

Data Sheet



Article number: 20662174

Description: E+G Levelling set
GN 350-32-9-A-NI

Measures

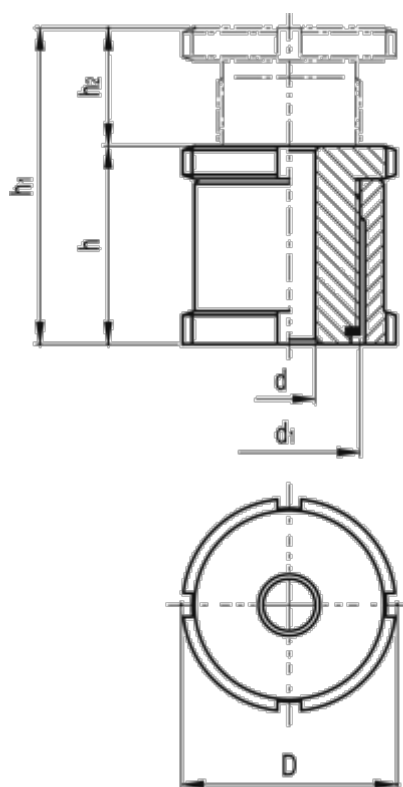

C-spanner DIN 1810 = A30-32

d = 9.0

D = 32

d_1 = M20x1

For screw = M8

h = 35

h_1 = 55

h_2 = 20

Max static load (N) = 43.4

Static preload (N) = 30.9

Weight (g) = 154